

1497

108

1325

2000

210

210

528

850

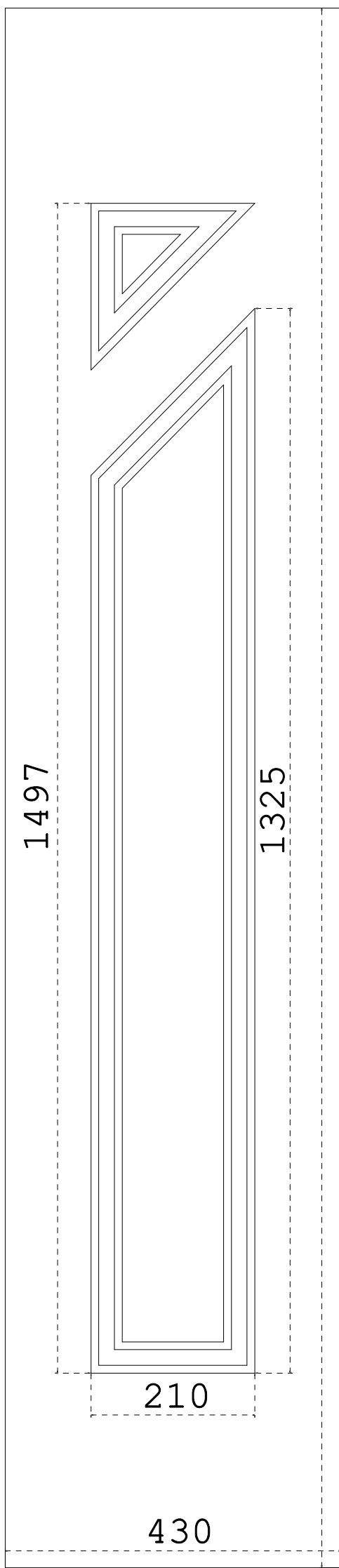

1497

1325

210

430

2000